

GAS WATER HEATER**Owner's Guide**

**Models YS2180RA YS2180RA5 YS2180RAP YS2180RA5P
YS1780RA YS1780RA5 YS1780RAP YS1780RA5P**

**WARNING**

If the information in this manual is not followed exactly, a fire or explosion may result causing property damage, personal injury, or death.

- Do not store or use petrol or other flammable vapours and liquids in the vicinity of this or any other appliance.**
- WHAT TO DO IF YOU SMELL GAS**
 - Do not try to light the appliance.**
 - Do not touch any electrical switches; Do not use electrical appliances, including the phone” inside the building.**
 - Immediately call you gas supplier, from a safe distance from the gas leak.**
- To be installed and serviced only by an authorised person**
- This appliance is not suitable for use as a pool heater**

Thank you for purchasing this Bosch Gas Water Heater.

Before using, please:

Read this manual completely for operation instructions.

Confirm warranty and proof of purchase.

Keep this manual where it can be found whenever necessary.

Installation must conform with local codes, or in the absence of local codes, AS/NZS5601, AS/NZS3500.4, AS3000 wiring regulations and all Local Building, Water and Gas fitting regulations.

Bosch reserves the right to discontinue, or change at any time, the designs and/or specifications of its products without notice.

* Note : This appliance requires a minimum flow rate to operate of 2.5 litres/min., water fixtures with a flow rate of 7.5 litres/min. or higher are recommended.
For optimum performance we reommend installation of Bosch optional temperature controllers.

Robert Bosch (Australia) Pty. Ltd.





Important Safety Information

To prevent damage to property and injury to the user, the icons shown below will be used to warn of varying levels of danger.

Every indication is critical to the safe operation of the water heater and must be understood and observed. Potential dangers from accidents during installation and use are divided into the following four categories. Closely observe these warnings; they are critical to your safety.

■ Icons warning of risk level



This is the safety alert symbol. It is used to alert you to potential personal injury hazards. Obey all safety messages that follow this symbol to avoid possible injury or death.



DANGER

DANGER indicates an imminently hazardous situation which, if not avoided, will result in death or serious injury.



WARNING

WARNING indicates a potentially hazardous situation which, if not avoided, could result in death or serious injury.



CAUTION

CAUTION indicates a potentially hazardous situation which, if not avoided, may result in minor or moderate injury.

CAUTION

CAUTION used without the safety alert symbol indicates a potentially hazardous situation which, if not avoided, may result in property damage.

■ Other icons



Electric Shock.



High Temperature.



Be sure to do.



Earth



Prohibited



No flame.



Don't touch.



Don't disassemble the equipment.



Don't touch with a wet hand.



DANGER



Prohibited

Vapours from flammable liquids will explode and catch fire causing death or severe burns.

Do not use or store flammable products such as petrol, solvents or adhesives in the same room or area near the water heater.

Keep flammable products: Vapours:

1. Far away from the water heater.
2. In approved containers.
3. Tightly closed.
4. Out of children's reach.

1. Cannot be seen.
2. Vapours are heavier than air.
3. Go a long way on the floor.
4. Can be carried from other rooms to the main burner by air currents.



Prohibited

Hot Water Heater temperatures over 50 °C can cause severe burns instantly or death from scalding.

Children, disabled and elderly are at the highest risk of being scalded. Feel water temperature before bathing or showering. Temperature limiting valves are available, ask licensed installer.

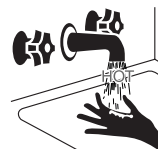



(Continued)



Prohibited

Do Not Install Indoors.

This will cause carbon monoxide poisoning and a potential fire hazard.

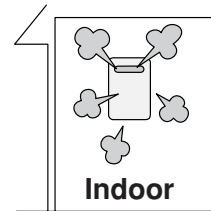

Indoor

WARNING



No flame.

A. This water heater does not have a pilot. It is equipped with an ignition device that automatically lights the burner. Do not try to light the burner by hand.

B. BEFORE OPERATING smell all around the water heater area for evidence of leaking gas. Be sure to smell next to the floor because some gas is heavier than air and will settle on the floor.

WHAT TO DO IF YOU SMELL GAS.

- Do not try to light any appliance.
- Do not touch any electrical switch; do not use any phone in your building.
- Immediately call your gas supplier. Follow the gas supplier's instructions.

C. Use only your hand to turn the gas valve knob. Never use tools. If the knob will not turn by hand, don't try to repair it. Call a qualified service technician. Force or attempted repair may result in a fire or explosion.

D. Do not use this water heater if any part has been under water. Immediately call a qualified service technician to inspect the water heater and to replace any damaged parts.



Be sure to do.

When a gas leak is noticed:

1. Stop use immediately
2. Close the gas valve
3. Contact your gas supplier immediately



Be sure to do.

If you detect abnormal combustion or abnormal odours, or during an earthquake, tornado or fire:

1. Turn off the hot water supply
2. Turn off the power to the water heater
3. Turn off gas and water supply valve.
4. Call the Bosch Helpline
AU 1300 30 70 37 NZ 0800 54 33 52.



High Temperature.

Check the temperature of the running hot water before entering the shower.



Check the temperature before stepping into the bath tub.



Be sure to do.

Leave the proper clearance between the water heater and nearby objects (trees, timber, boxes with flammable materials etc.).

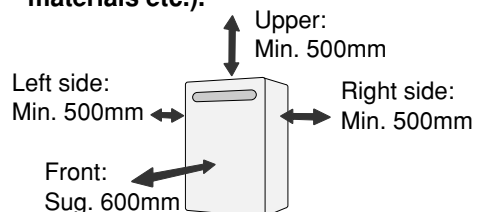

(Continued)



Important Safety Information

(Continued)



Do not place the unit in an indoor environment by means of adding walls and ceiling (Do not enclose using corrugated sheets, etc.)

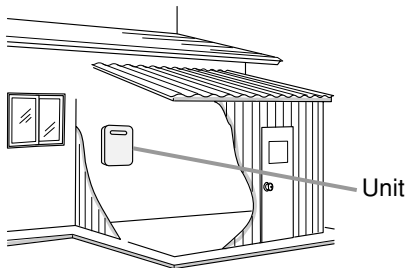

Carbon monoxide poisoning or fire may occur as a result.



Carbon Monoxide Poisoning Hazard. Do not install this water heater in a mobile home, recreation vehicle or on a boat.



Do not place combustibles such as laundry, newspapers, oils etc. near the heater.

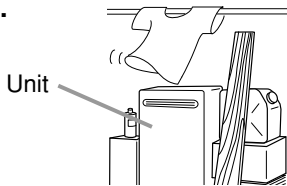

Do not use combustible chemicals such as oil, petrol, benzene etc. in the near the water heater or the exhaust vent.



Do not store or use petrol or other flammable vapours and liquids in the vicinity of this or any other appliance.



Do not place or use a spray can near the water heater or the exhaust vent.



Be sure to do.

Be sure the gas matches the gas on the data plate (inside of frontcover) or gas type label (right side of casing).

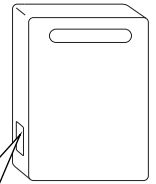

Ex. For Natural Gas (YS2180RA)

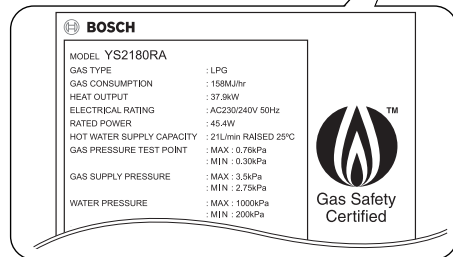

Be sure to do.

Installation and service must be performed by a qualified installer, service agency or the gas supplier.



Prohibited

Do not use hair spray or spray detergent in the vicinity of the heater.



Prohibited

Do not allow small children to play unsupervised in the bathroom. Do not allow small children to bathe unsupervised.



Don't touch with a wet hand.



Electric Shock.

Do not touch the power cord with wet hands.



Be sure to do.

Contact Bosch before using with a solar pre-heater.



Don't disassemble the equipment.

Contact a qualified service technician for any necessary repairs, service or maintenance.



CAUTION



Earth

Be sure to electrically earth the unit.



Be sure to do.

Keep power cord free of dust.



Prohibited

Do not use the water heater for other than hot water supply, shower and bath.



Prohibited

Do not use a broken or modified power cord. Do not bind, bend or stretch power cords. Do not scratch, modify, or subject them to impact or force.



Be sure to do.

To prevent burns or scalding, turn off the power button and wait until the equipment cools before performing maintenance.



Prohibited

Do not turn off the water heater while someone is bathing.



Prohibited

Do not cover the water heater, store trash or debris near it, or in any way block the flow of fresh air to the unit.



Prohibited

Do not install in locations where excessive dust or debris will be in the air.



Don't touch.

Do not touch the exhaust vent during or immediately after operation of the water heater.





Important Safety Information

CAUTION

Do not drink water that has been inside the unit for an extended period of time. Do not drink the first use of hot water from the unit in the morning.

Clean the filter on the water inlet as frequently as required. The quality of your local water will affect the frequency required.

Keep the area around the unit clean.

If boxes, weeds, cobwebs, cockroaches etc. are in the vicinity of the unit, damage or fire can result.

Do not install the equipment where the exhaust will blow on walls or windows.

Treat hard, acidic or otherwise impure supply water with approved methods to ensure full warranty coverage.

Problems resulting from scale formation are not covered by the warranty.

Do not run water through the unit when unit is not on.

When discharging hot water, make sure the unit is ON. If water is run through the unit with the unit OFF, water may condense inside the unit and cause incomplete combustion or damage to the internal electrical components.

Do not disassemble the remote controller.

Do not use benzene, oil or fat detergents to clean the remote controller.

This may cause deformation.

Do not get the remote controller wet.

YPRS67XBN and YPRP62XBN are water resistant, too much water can cause damage. YPRM67XBN is not water resistant.

Do not splash water on the remote controller. Do not expose the remote controller to steam.

Do not locate the remote controller near stoves or ovens, this may cause damage or failure.

Preventing damage from freezing (→ p.22)

Damage can occur from frozen water within the device and pipes even in warm environments. Be sure to read below for appropriate measures. Repairs for damage caused by freezing are not covered by the warranty.

Power must be switched on at all times for antifrost protection to work.

If it is snowing, check the air inlet, exhaust gas vent and exhaust vent terminal for blockage.

Do not use parts other than those specified for this equipment.



Contents

Important Safety Information	2
Contents	7
General Parts	
Main Unit	8
Names and Functions of Controllers	
Main Controller (YPRM67XBN)	9
Bathroom Controller (YPRS67XBN)	10
Sub Controller (YPRP62XBN)	11
Initial Operation	12
Clock Adjustment	13
Setting and Using the Water Heater	14
Controller Priority Function	16
Muting the Remote Controller	17
Bath Fill Function	18
Call Function	21
Frost Protection	22
Regular Maintenance	23
Troubleshooting	25
Follow-up Service	29
Specifications	30
Manufacturer's Warranty	35



General Parts

Main Unit

Outdoor Wall Mounted, Power flue Model

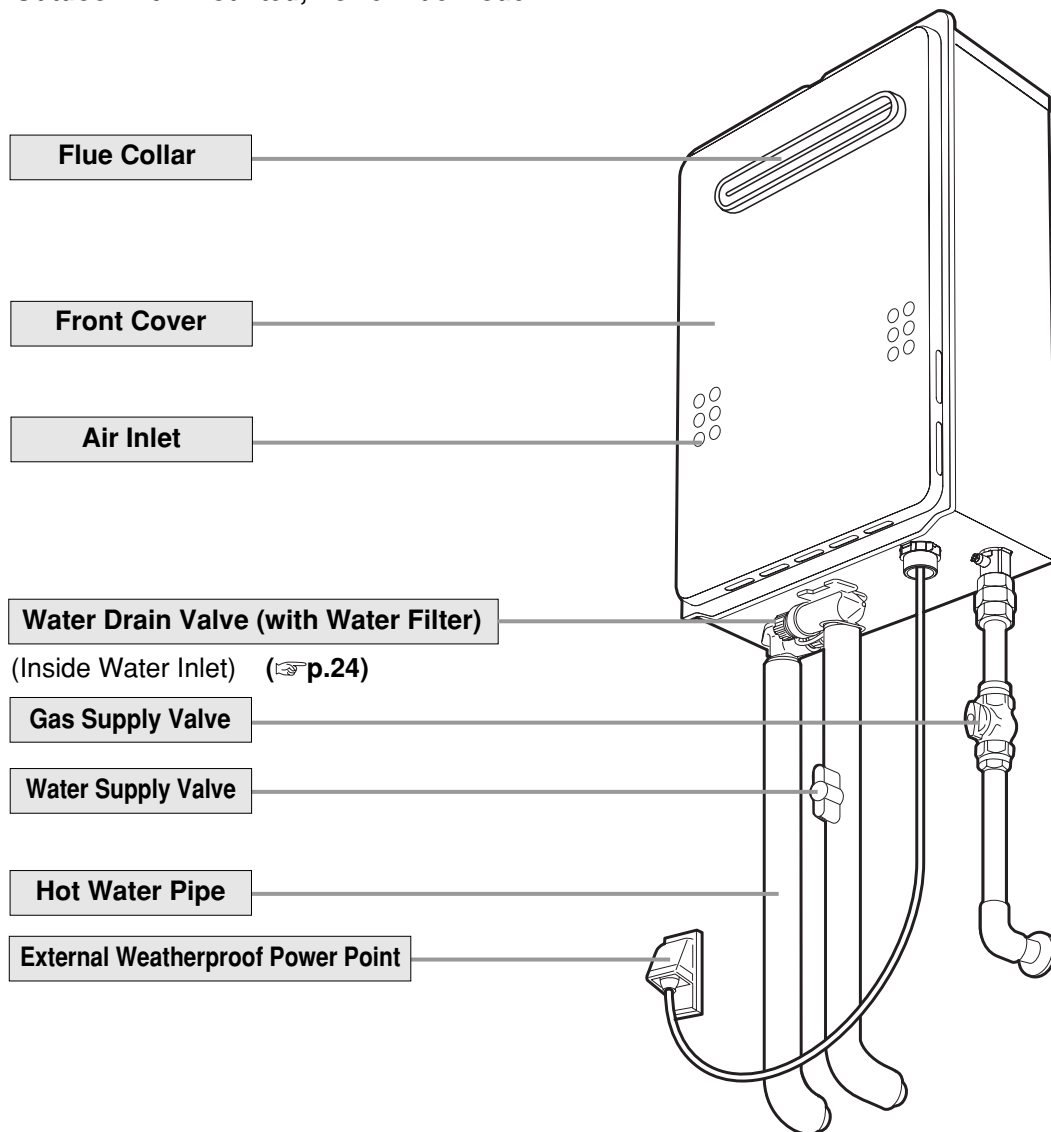

* The above illustration shows an example of installation.
The exact installation configuration may be slightly different.



Names and Functions of Controllers

Main Controller (YPRM67XBN) <Optional>

What is actually displayed depends on how the water heater is set.

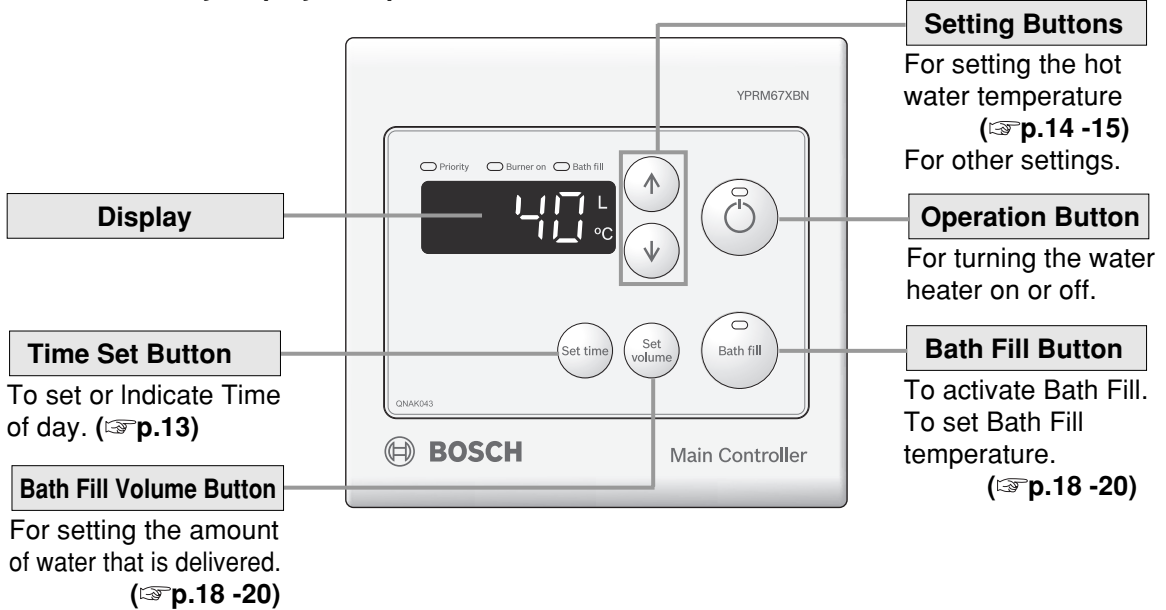

* Before use, remove the protective sheet from the remote controller surface.

Display

The illustration below shows the remote controller display. What is actually displayed depends on how the water heater is set.

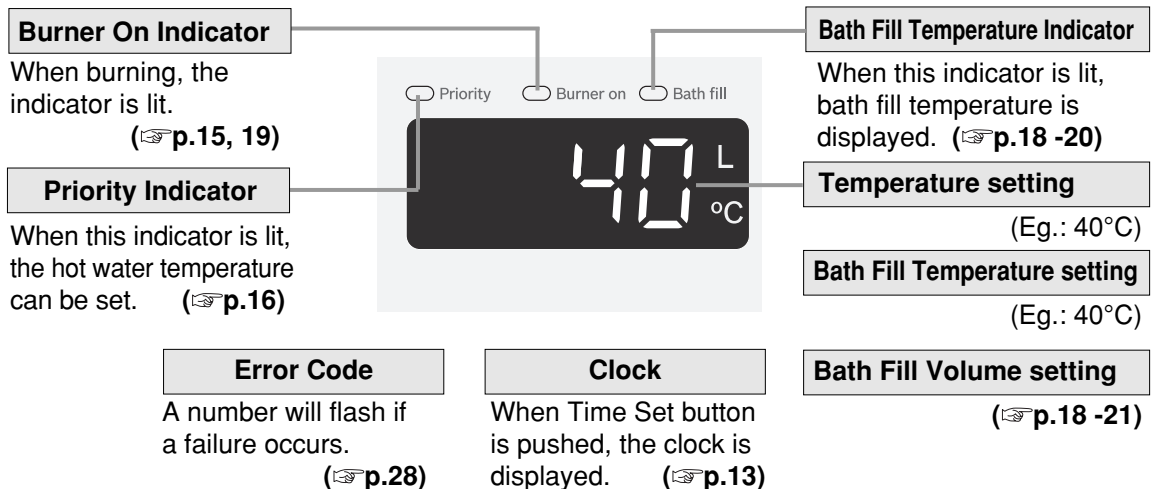



Bathroom Controller (YPRS67XBN) <Optional>

What is actually displayed depends on how the water heater is set.

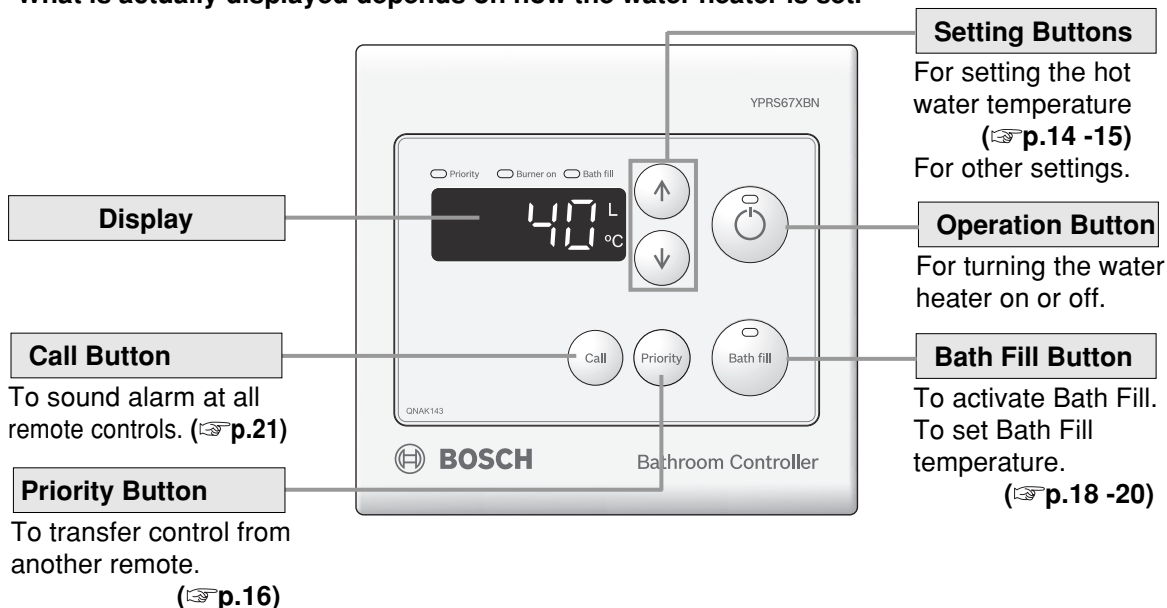

* Before use, remove the protective sheet from the remote controller surface.

Display

The illustration below shows the remote controller display.
What is actually displayed depends on how the water heater is set.

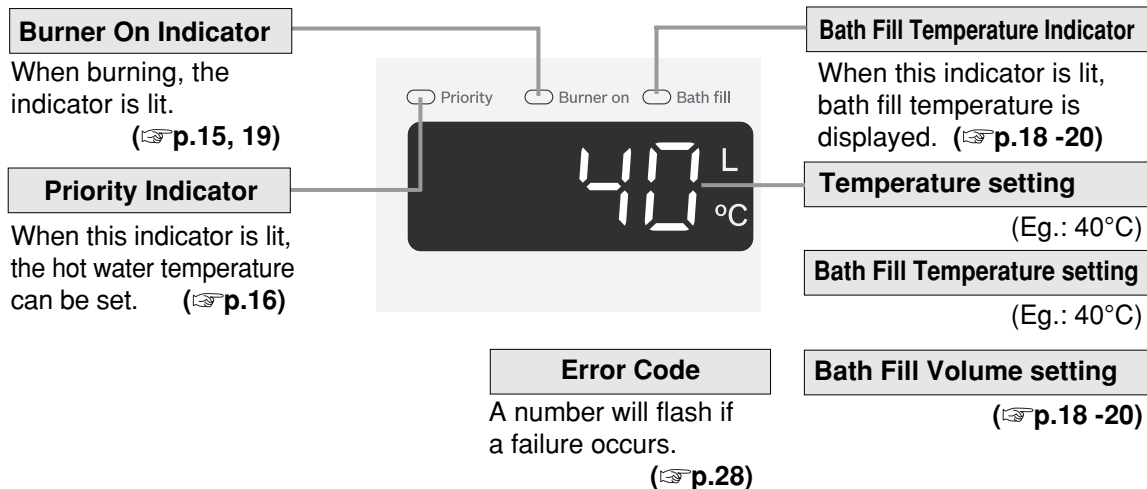



Sub Controller (YPRP62XBN) <Optional>

What is actually displayed depends on how the water heater is set.

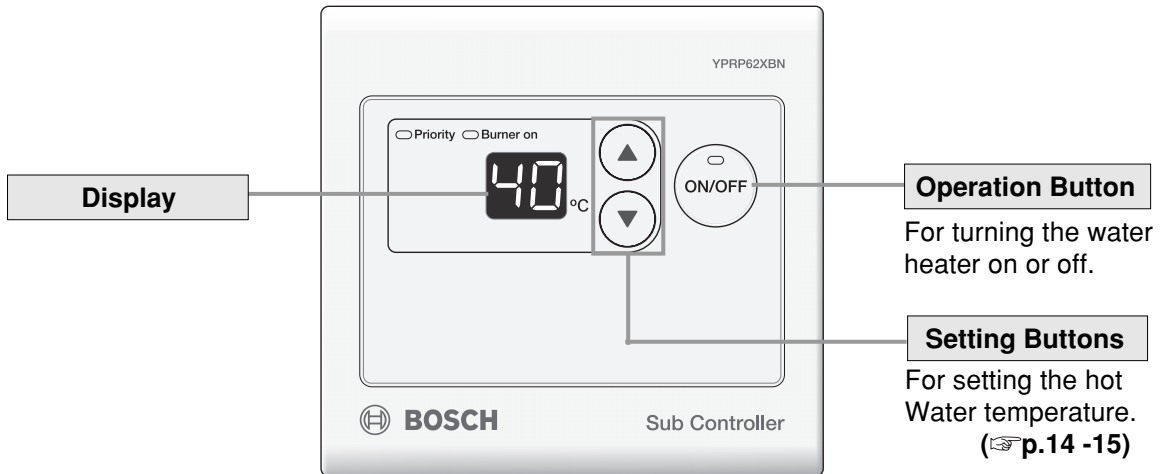

* Before use, remove the protective sheet from the remote controller surface.

Display

The illustration below shows the remote controller display. What is actually displayed depends on how the water heater is set.

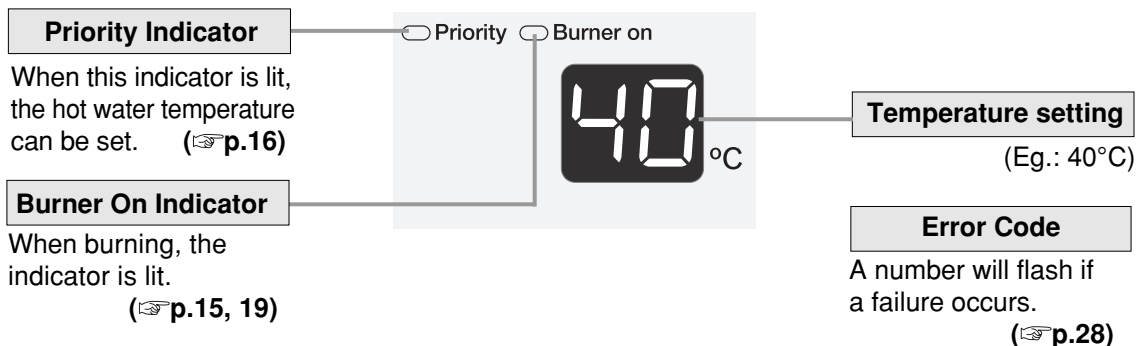



Initial Operation

Before the first use of your water heater, make the following preparations.

Follow steps **1 through 4.**

1 Open the water supply valve.

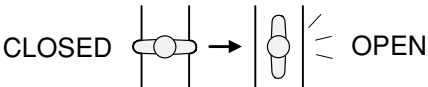

2 Open a hot water fixture to confirm that water is available, and then close the fixture again.

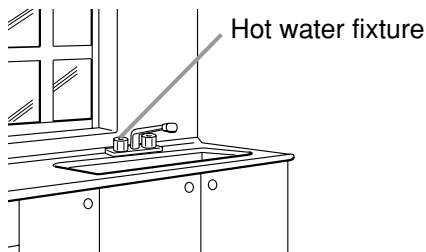

3 Open the gas supply valve.

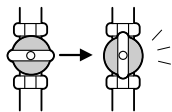

4 Turn on the power.

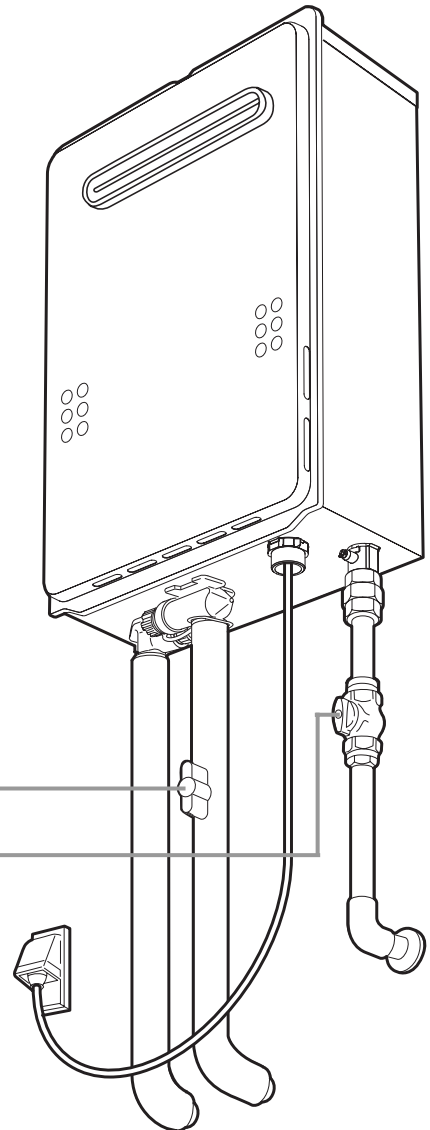



Clock Adjustment

(Main Controller)

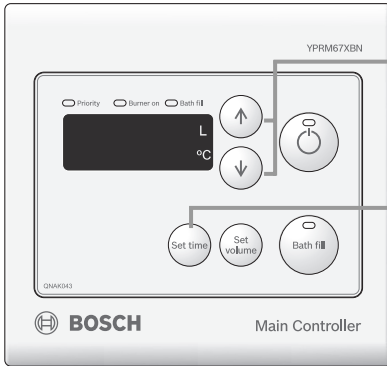

2

1, 3

Note: Only the main controller has a clock function.

Clock setting and the clock can be displayed regardless of "ON or OFF" of the operation button.
(The illustration is in a state of "OFF".)

1 Press the Set Time Button (Until "0:00" is flashing)



Flashing



2 Adjust the clock

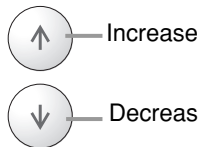

The time changes in 1-minute increments with each press on the button, and then in 10-minute increments if the button is kept pressed down.

Flashing



(Eg.: 10:15)

3 Press the Set Time Button



The flashing changes to constant illumination when the clock has been set.

Flashing

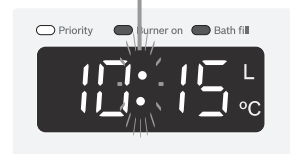

Display the clock

Press the set time button.
The clock display will then return to the original screen display.



- The clock display will disappear if hot water is used or the temperature of the hot water is changed during the clock display.
- If the Time set button is pushed when the hot water is being used or a high temperature (60°C) is set, the clock is displayed for 10 seconds and will return to the original screen display after that.
- In the event of a power cut or after disconnecting the power supply, the clock on the display screen will show 0:00 when the power is restored. In this case the clock will need to be reset.



Setting and Using the Water Heater

(Main Controller)

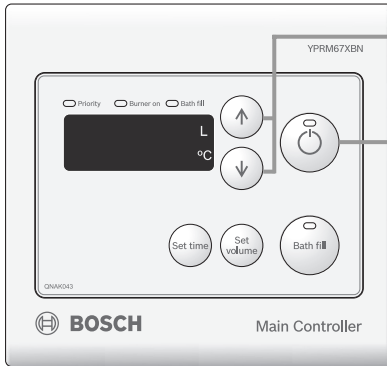

2

1

(Starting with the Operation Off)

1 Press the Operation Button.

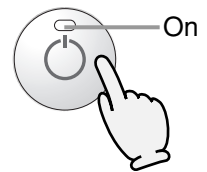

The temperature will be displayed on the remote control thermostat.

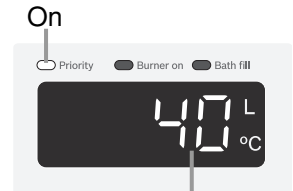

Previous set temperature (Eg.: 40°C)



DANGER



To prevent scalding:
High Temperature

Hot Water Heater temperatures over 50°C can cause severe burns instantly or death from scalding.

- Children, disabled and elderly are at the highest risk of being scalded. Feel water temperature before bathing or showering. Temperature limiting valves are available, ask licensed installer.
- When setting the unit to 60°C (p.15), the temperature display will flash for 10 seconds.
- Take caution when using the unit again after setting to 50°C or higher. Always check the set temperature before use.

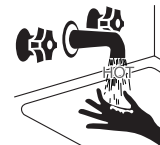

Remote Controller Display

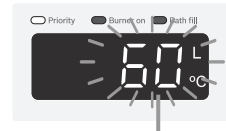

Flashes for 10 sec





2 Set temperature. (Always check the temperature setting before use.)

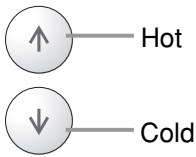

Check the indicator lights.

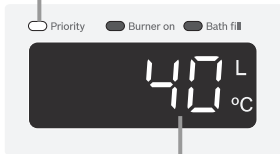

Water temperature



3 Turn on hot water.



On

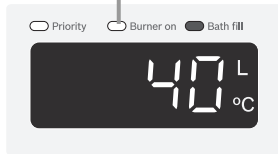

4 Turn off the hot water.



Off

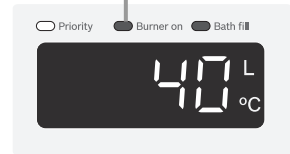

(°C · The temperature settings below are examples. The temperature setting necessary depends on the usage, the length of piping or seasons.)

Bathroom and Sub controller are these ranges.

[RA5: Main and Bathroom and Sub controller are these ranges.]

37	38	39	40	41	42	43	44	45	46	47	48	50	55	60
Shower, hot water supply, etc.							Hot water supply, etc.					High temperature		

*Initial factory setting is 40°C

* For most residential applications, the recommended setting temperature is 50°C or less. For applications that occasionally require a higher temperature setting, locate the remote controller in a convenient location.

* Consult local codes for minimum operating temperatures.



Controller Priority Function

Priority

Hot water supplied from this appliance is delivered to the kitchen, washroom, and shower, etc. at the same temperature.

The water temperature can only be changed by one remote controller if a number of remote controllers are installed.

Only the controller with the priority light illuminated will be able to adjust the temperature of the water heater.

- The remote controller on which the operation button is turned “on” has priority.
- If the Bathroom or Sub controller has priority left ON, press OFF & ON any other controller to transfer priority to that controller. This function cannot be changed while the appliance is producing hot water (Except when hot water is operating).

When the temperature cannot be adjusted, follow the procedure below. <Priority button>

(Temperature settings for example.)

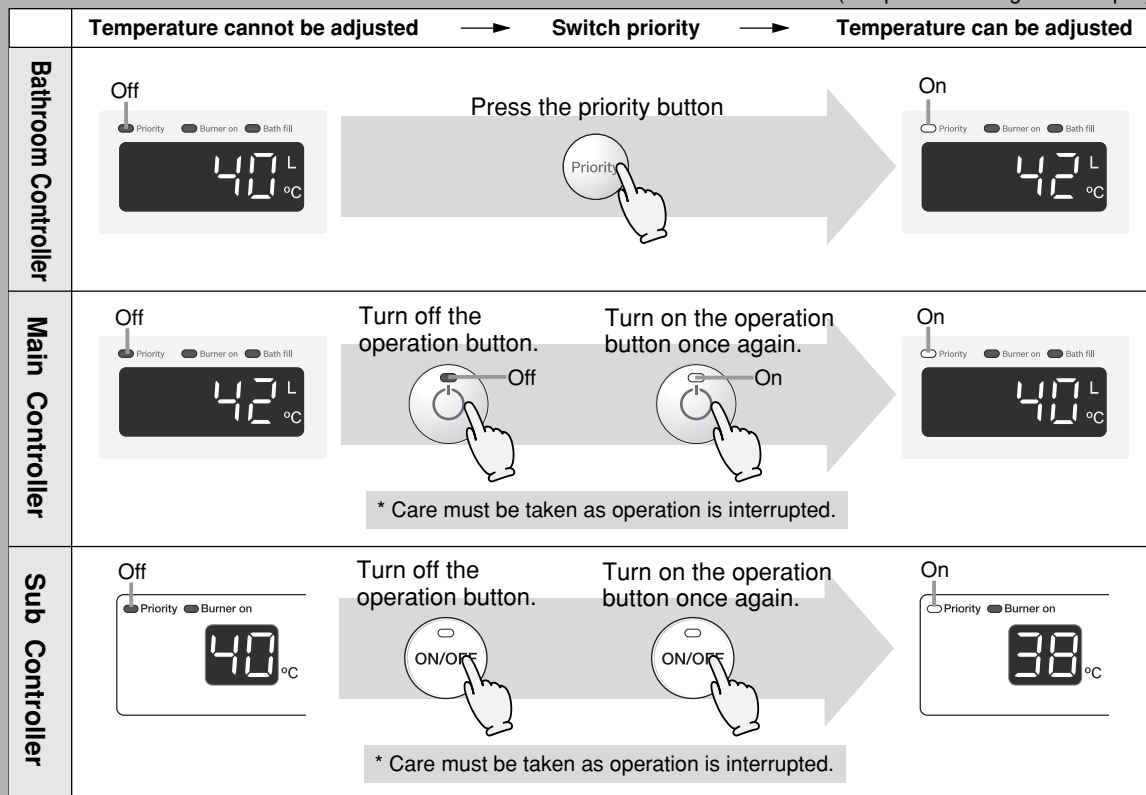



Muting the Remote Controller

(Main Controller)

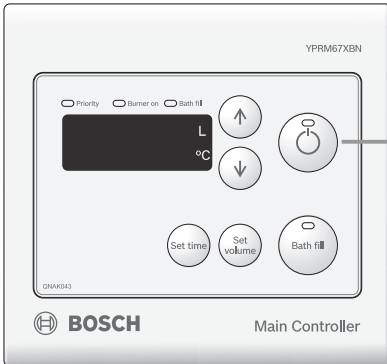

(Bathroom Controller)

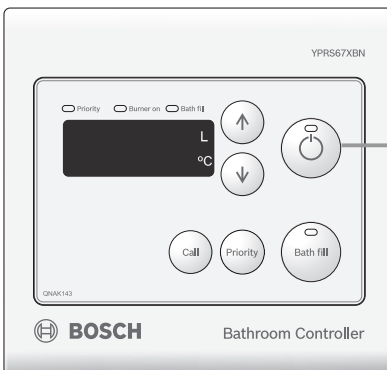

(Sub Controller)

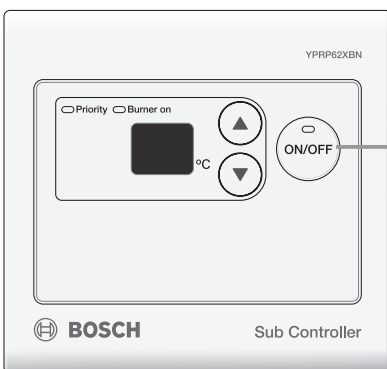

The remote controller will emit a sound when any button is pushed. This sound can be muted if it is desired.

* Initial factory setting is with sound

1 Hold the Operation Button for five seconds.

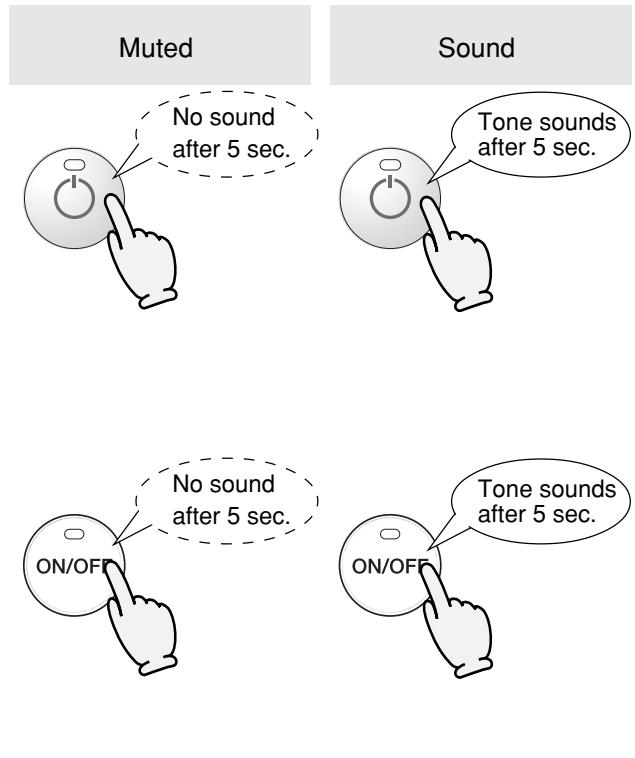

- The bath fill and the call function alarm are not muted.



Bath Fill Function

(Main Controller)

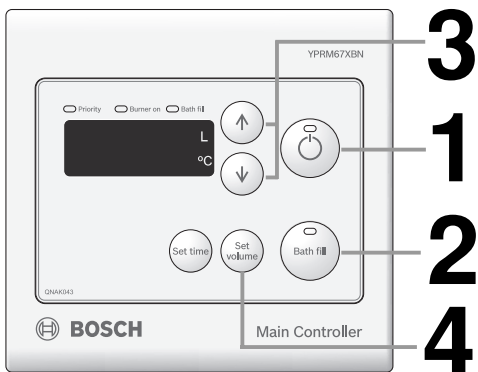

(Bathroom Controller)

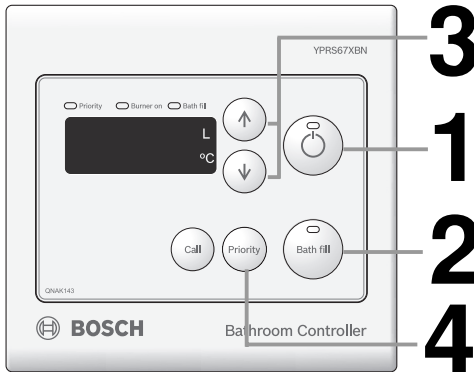

(Starting with the operation off)

Preparation

Plug the bath drain.

1 Press the Operation Button

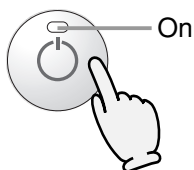

The temperature will be displayed on the remote control thermostat.

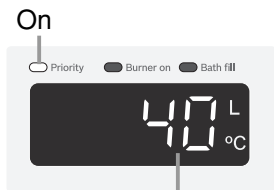

Previous set temperature (Eg.:40°C)

2 Press the Bath Fill Button

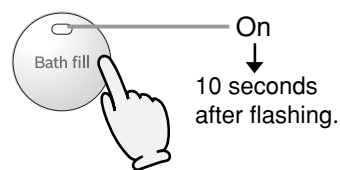

Flashes for 10 sec. → On



Bath Fill temperature (Eg.:42°C)

Flashes for 10 sec. → On



Filling Up the Bath

In order to run a warm bath, push the bath fill button and open the hot water tap of the bath.

When the bath has reached the volume set on the controller, an alarm sounds and the hot water supply will stop automatically.

Once the bath fill is complete, please close the tap as the water heater cannot operate until this is done.

Water Temperature

(°C: The temperatures settings below are only examples. The temperature setting necessary will depend on the usage, the length of piping or seasons.)

37	38	39	40	41	42	43	44	45	46	47	48
Warm			Warmer				Hot				

* Initial factory setting: 40°C

3 Set temperature. (Always check temperature setting before use.)

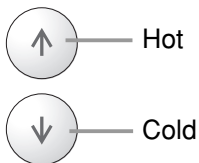

Check the indicator lights.



Bath Fill temperature

To set the Bath Fill Volume:

4 Adjust bath fill volume setting.

Press the Bath Fill button (the setting will flash on the display) and adjust with the setting buttons.

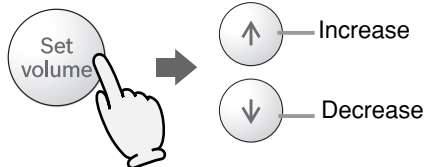

Choose the bath fill volume setting from the following options: 40 - 80 (In 20 litre intervals), 120 - 200 (In 40 litre intervals), or 250 - 650 (In 50 litre intervals).

* Initial factory setting: 160 litre.

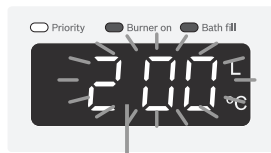

Bath fill volume setting will be flashing (Eg. 200 litre.)

* The level can only be adjusted while the indicator is flashing.

* After ten seconds, the remote will again display the temperature.

* For Bathroom controller.

To alter the bath fill volume press the priority button after the bath fill button.

5 Turn on hot water.

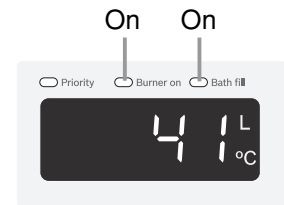
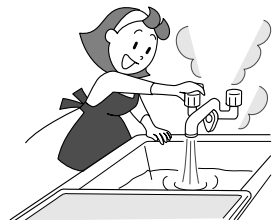



An alarm will sound for ten seconds when the flow reaches the set level.



And the hot water will stop automatically.

6 Turn off the hot water when the alarm sounds.

The alarm will sound when the set level has been reached. Stop the water.



*** When using hot water at another hot water outlet, also turn it off.**

<When you turn off the hot water supply>

- Bath fill temperature indicator turns off. (within approx. 30 seconds).

<If you do not turn off the hot water supply>

The equipment automatically runs the water to check if the hot water supply has been turned off.

<When approx. 10 minutes passes without turning off the hot water supply the sound is played>

The following screen appears, so turn off all the hot water supplies and then press the bath fill button.

- * Do not open the hot water supply until the Bath fill temperature indicator goes off.

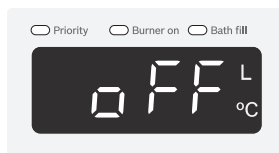

The setting temperature becomes the bath fill temperature after the bath fill was used.

If the bath fill is being used to indicate when a bath is full:

- If any hot water is being used besides what is going into the bath, the alarm will sound before the bath is full.
- If there was water in the bath before the fill began, the bath may overflow.
- If there was water in the bath before the fill began, the temperature in the bath after it is full may be different from the temperature setting.



Call Function

(Bathroom Controller)

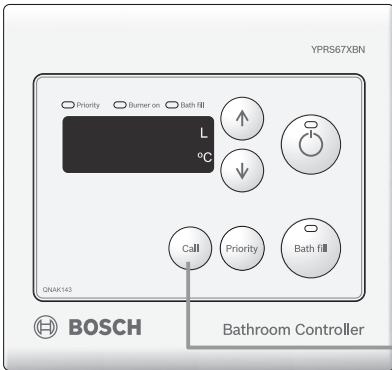

The call button can be used to sound an alarm at the Main Controller.
(Conversation is not possible as it is not an intercom.)

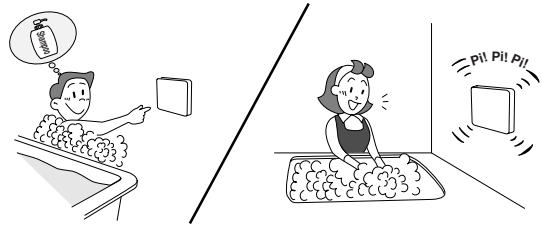

1 Press the call button.



The alarm sounds for as long as the button is pressed.

- The call button can be used regardless of whether the operation button is turned “on” or “off”.



Frost Protection

CAUTION

- * Damage can occur from frozen water within the device and pipes even in warm environments. Be sure to read below for appropriate measures.
- * Repairs for damage caused by freezing are not covered by the warranty.

Freezing is prevented within the device automatically by the freeze-prevention heater

Freezing cannot be prevented when the power plug is unplugged. Ensure that the appliance is plugged in and switched on at all times.

(Freezing will be prevented regardless of whether the operation switch is ON or OFF.)

- * The freeze prevention heaters will not prevent the plumbing external to the unit from freezing. Protect this plumbing with insulation, heat tape or electric heaters, solenoids, or pipe covers.

Take the measures below for extremely cold temperatures*.

(outside temperature including wind chill factor less than -15°C)

This method can protect not only to the heater, but also to the water supply, water piping and mixing valves.

1. Turn the unit off with the Operation Button on the Remote Controller.
2. Close the gas supply valve.
3. Open a hot water fixture, and keep a small amount of hot water running (400cc / minute or about 4mm thick).

* If there is a mixing valve, set it to the highest level.

4. The flow may become unstable from time to time. Check the flow 30 minutes later.

* In general, it is not advisable to run water through the unit when it is OFF (→ p. 6), but in this case freeze prevention is more important.

Hot Water Fixture

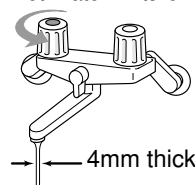

If water will not flow because it is frozen

1. Close the gas and water valves.
2. Turn off the operation button.
3. Open the water supply valve from time to time to check whether water is running.
4. When the water is flowing again, check for water leaks from the equipment and piping before using.

If the heater or the piping is frozen, do not use the heater or it may get damaged.



Regular Maintenance

Periodic Inspection



CAUTION



Be sure to do.

To prevent burns or scalding, turn off the operation button and wait until the equipment cools before performing maintenance.

Check

For laundry, newspaper, timber, oil, spray cans and other combustible materials.

Check

For abnormal sounds during operation.

Check

For abnormalities in external appearance, discoloration or flaws.

Check

For water leaks from the equipment and piping.

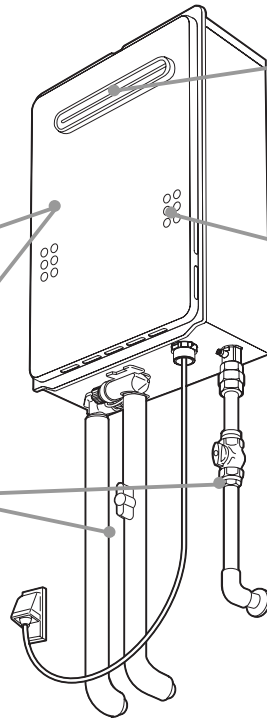

Check

For dust and soot in the flue collar.

Check

For dust or debris in the air inlet.

Periodic Maintenance

Equipment

Wipe the outside surface with a wet cloth, then dry the surface. Use a neutral detergent to clean any stains.

Remote Controller

Wipe the surface with a wet cloth.

- Do not use benzene, oil or fatty detergents to clean the remote controller; deformation may occur.
- YPRS67XBN, YPRP62XBN are water resistant but not water proof. Keep it as dry as possible. YPRM67XBN is not water resistant.



Periodic Maintenance

Water Drain Valve (with Water Filter)

If the water drain valve (with water filter) is covered with debris, the hot water may not run smoothly, or the unit may put out cold water. Check and clean the filter as explained below.

* **To avoid burns, wait until the equipment cools down before draining the water. The appliance will remain hot after it is turned off.**

1. Close the water supply valve.
2. Open all hot water fixtures.
3. With a bucket ready, remove the inlet and outlet drain plugs (about 1 L. will drain out)
4. Take the water drain valve (with water filter) out of the inlet. (See illustration to right).
5. Clean the water drain valve (with water filter) with a brush under running water.
6. Replace the water drain valve (with water filter) and close the drain plugs.
(Take care not to lose the packing.)
7. Close all hot water fixtures.
8. Open the water supply valve and check that water does not leak from the drain plugs or water drain valve (with water filter).

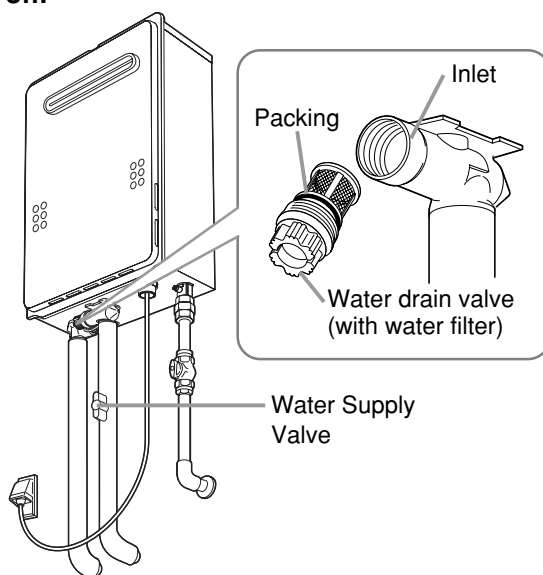

* This water heater should be serviced by an authorised person at regular intervals not exceeding 2 years.



Troubleshooting

Initial Operation

Unit does not attempt to ignite when water is running.

- Check for reversed plumbing or crossed pipes.
- Check the water drain valve filter. (→p.24)

Unit attempts to ignite but fails

- Reset unit and try again. There may be air in the gas line.
- Have a professional check the gas supply pressure.

Temperature

Hot water is not available when a fixture is opened.

- Are the gas and water supply valves fully open?
- Is the water supply cut off?
- Is the hot water fixture sufficiently open?
- Is the gas being cut off by the gas meter?
(Can other gas devices such as stoves be used?)
- (For LP) Is there enough gas in the tank?
(Can other gas devices such as stoves be used?)
- Is the water drain valve filter clogged? (→p.24)
- Is the operation button turned on?

No water is available when a fixture is opened.

- Is the water supply cut off?
- Is the heater frozen?

The hot water is not the correct temperature.

- Is the hot water fixture sufficiently open?

Water takes time to become hot when turning the hot water fixture.

- Have you allowed enough time for the cold water in the pipes to drain out?

The water is too hot.

- Are the gas and water supply valves fully open?
- Is the water temperature setting appropriate?
(→p.14 and p.15)
- If the water supply temperature is high, it is possible for the temperature to be higher than the temperature set on the remote controller.
- If only a small amount of hot water is demanded, it is possible for the temperature to be higher than the temperature set on the remote controller.

The water is not hot enough.

- Are the gas and water supply valves fully open?
- Is the water temperature setting appropriate?
(→p.14 and p.15)

(Continued)

(Continued)

The water is cold when only a single fixture is open.	<ul style="list-style-type: none"> The unit will not heat the water if the flow rate is less than 2.5 litre per minute. Open the fixture more or open other fixtures so that a greater flow passes through the unit, and the unit should begin heating again.
Fluctuations in hot water temperatures.	<ul style="list-style-type: none"> Set water temperature at 48°C to 50°C. This will allow you to use a higher flow of hot water thus meeting the minimum flow requirement of 2.5 L/min. Clean the water filter of any debris ( p.24)

Amount of Hot Water

The amount of hot water at a certain fixture is not constant.	<ul style="list-style-type: none"> When hot water is demanded at other fixtures, the amount available may be reduced. The maximum flow available from YS2180 RA (5) (P) (5P) is 21 L /min., YS1780 RA (5) (P) (5P) is 17 L /min. at a 25°C temperature rise. Pressure fluctuations and other plumbing conditions can cause the temperature and pressure at a fixture to be unstable, but it should stabilize after a short time. There are some types of hot water taps that discharges large volumes of hot water at first but stabilize after time. To keep the temperature stable, the heater limits the amount of water that can flow through it to a small amount initially, but the amount increases over time.
The amount of hot water in the bath is less/more than the set amount.	<ul style="list-style-type: none"> When hot water is used for other fixtures while filling the bath, the bath will not fill as much. If there is water in the bath already, or when filling is stopped and restarted, the bath will fill more.
The bath fill alarm does not sound even when filled to the set amount.	<ul style="list-style-type: none"> The bath fill alarm is set to sound when hot water is continuously discharged for the set volume of water. If mixing valves are used, or if cold water is mixed with hot water at the fixture, the bath will fill more than the setting of the bath fill function.
Amount of hot water available has decreased over time.	<ul style="list-style-type: none"> Is the water filter clogged? ( p.24)

Remote Controller

The light on the operation button does not come on.	<ul style="list-style-type: none"> Has there been a power failure? Is the power connected properly?
---	---

(Continued)



(Continued)

Clock shows "0:00".	<ul style="list-style-type: none"> • If the power is disconnected for any reason, when the power is reconnected, the clock on the display screen shows "0:00", indicating that it needs to be reset. (→ p.13)
The water temperature changes after a power failure or when the power is disconnected.	<ul style="list-style-type: none"> • The temperature setting and the bath fill setting may both need to be reset after a power outage.
The plastic on the surface or buttons of the remote controller has torn, peeled, or air bubbles inside.	<ul style="list-style-type: none"> • The surface of the remote controller is affixed with a protective sheet (to prevent surface scratching, etc.) at time of shipment. This sheet can be removed or left as it is. When leaving the protective sheet on, areas frequently touched may tear or peel. However, the remote controller will not malfunction from water entering such torn or peeled areas. To restore the appearance of the remote controller surface, simply remove the protective sheet.

Sounds

<p>The fan can be heard after operation is stopped.</p> <p>A motor can be heard when turning the unit ON or OFF, when opening or closing a fixture, or after the unit has been running for a while.</p>	<ul style="list-style-type: none"> • These noises indicate the proper operation of devices which are designed to let the unit reignite more quickly, and ensure the water temperature is stable.
---	---

Other

The heater stops burning during operation.	<ul style="list-style-type: none"> • Are the gas and water supply valves fully open? • Is the water supply cut off? • Is the hot water fixture sufficiently open? • Is the gas being cut off by the gas meter? (Can other gas devices such as stoves be used?) • (For LP) Is there enough gas in the tank? (Can other gas devices such as stoves be used?)
White smoke comes out of the flue collar on a cold day.	<ul style="list-style-type: none"> • This is normal. The white smoke is actually steam.

(Continued)

(Continued)

The hot water is turbid.	<ul style="list-style-type: none"> This is harmless. Small bubbles appear as the air in the water is heated and depressurized rapidly to atmospheric pressure.
The water appears blue The bath tub/wash-basin has turned blue.	<ul style="list-style-type: none"> Coloration to a blue colour may be noticed from small traces of copper ion contained in the water and fat (furring). However, there are not problems concerning health. Coloration of the bath tub/wash-basin can be prevented by cleaning frequently.

Check for an Error Code

If there is a problem with the unit, a numerical error code will flash on the remote controller.

If this occurs, take appropriate measures as listed below.

When an error code appears, the display and the operation light will flash together.

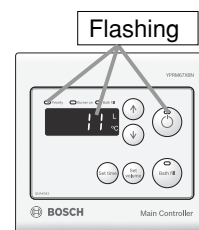

Main Controller

Error Code	Cause	Action
11	Ignition error	Check whether the gas valve is open. Press the operation button to turn the unit off, open a hot water fixture, and turn the unit back on. If the flashing number doesn't return the problem is solved.
90	Abnormal combustion, low gas supply pressure	Have a professional check the gas supply pressure. Contact Bosch 1300-30-70-37.
99	Abnormal combustion	Contact the installer or Bosch Service Department for assistance.

Contact Bosch if:

- Any other error code appears.
- An error code is indicated again after the above actions were followed.
- There are any other questions.



Follow-up Service

Requesting Service

First follow the instructions in the troubleshooting section (☞ p.25 to p.28).
If the error is not corrected, contact Bosch Service Department at 1300-30-70-37.

We will need to know:

The Models YS2180RA YS2180RA5 YS2180RAP YS2180RA5P
YS1780RA YS1780RA5 YS1780RAP YS1780RA5P

Date of purchase (see the warranty)

Details of problem ... (flashing error codes, etc., in much detail as possible)

Your name, address, and telephone number

Desired date of visit



Warranty

For repairs after the warranty period, there will be a charge on any service, and service will only be performed if the unit is deemed repairable.

See warranty Document on page 35.

Period of Time for Stocking Repair Parts

Bosch will stock repair and maintenance parts for this unit within ten (10) years of the date of original manufacture.

Reinstallation

If you want to reinstall the appliance at a different location, confirm that the gas and power supply indicated on the data plate are available at the new location. If you are not sure, consult the local utility company.

If you move to a region that uses a different type of gas, conversion and adjustment of the appliance will be necessary.



Specifications

Specifications

Model Name	YS2180RA	YS2180RA5	YS2180RAP	YS2180RA5P
Approval certification number	SAI-400151			
Type	Installation	Outdoor, Wall Mounted		
	Air Supply/Exhaust	Power Flue		
Operating Pressure	200 -1,000 kPa			
Minimum Flow Rate	2.5 L/min.			
Dimensions	520mm (Height) x 350mm (Width) x 170mm (Depth)			
Weight	15 kg			
Water Holding Capacity	0.5 L			
Connection Sizes	Water Inlet	R 3/4 (20mm)		
	Hot Water Outlet	R 3/4 (20mm)		
	Gas Inlet	R 3/4 (20mm)		
Power Supply	Supply	230 / 240 VAC (50Hz)		
	Consumption	NG:39.4W	LP:45.4W	Freeze Prevention 129W
Accessories	Anchoring Screws			

Performance

Item		Maximum Performance
Gas Consumption	NG	159 MJ/hr
	LP	158 MJ/hr
Maximum Hot Water Capacity	25°C Rise	21 L/min.



- Specifications may be changed without prior notice.
- The capacity may differ slightly, depending on the water pressure, water supply, piping conditions, and water temperature.

Specifications

Model Name	YS1780RA	YS1780RA5	YS1780RAP	YS1780RA5P
Approval certification number	SAI-400151			
Type	Installation	Outdoor, Wall Mounted		
	Air Supply/Exhaust	Power Flue		
Operating Pressure	200 -1,000 kPa			
Minimum Flow Rate	2.5 L/min.			
Dimensions	520mm (Height) x 350mm (Width) x 170mm (Depth)			
Weight	14 kg			
Water Holding Capacity	0.5 L			
Connection Sizes	Water Inlet	R 3/4 (20mm)		
	Hot Water Outlet	R 3/4 (20mm)		
	Gas Inlet	R 3/4 (20mm)		
Power Supply	Supply	230 / 240 VAC (50Hz)		
	Consumption	NG:33.3W	LP:36.5W	Freeze Prevention 129W
Accessories	Anchoring Screws			

Performance

Item		Maximum Performance
Gas Consumption	NG	126 MJ/hr
	LP	130 MJ/hr
Maximum Hot Water Capacity	25°C Rise	17 L/min.



Note



Note

WATER QUALITY

All Bosch water heating appliances are constructed from high quality materials and components and all are certified for compliance with relevant parts of Australian and New Zealand gas, electrical and water standards.

Whilst Bosch water heaters are warranted against defects, the warranty is conditional upon correct installation and use, in accordance with detailed instructions provided with the heater. In the case of the water supplied to the heater, it is important that the water quality be of acceptable standard.

The water quality limits/parameters listed in water quality table are considered acceptable and generally, Australian and New Zealand suburban water supplies fall within these limits/parameters.

In areas of Australia and New Zealand where water may be supplied, either fully or partly, from bores, artesian wells or similar, one or more of the important limits may well be exceeded and the heater could, therefore, be at risk of failure.

Where uncertainty exists concerning water quality, intending appliance users should seek a water analysis from the water supplying authority and in cases where it is established that the water supply does not meet the quality requirements of the water quality table, the Bosch warranty would not apply.

WATER QUALITY TABLE

Maximum levels

pH	Saturation Index(LSI) (langelier)	Total Hardness	Chlorides	Sodium	Iron
6.5-9	+0.4 to Minus 1.0 @65C	200mg/l	250mg/l	180mg/l	1mg/l



**Robert Bosch (Australia) Pty Ltd (Bosch)
Manufacturer's Warranty
(Applicable for purchases from 1 January 2012)**

All Bosch hot water units are carefully checked, tested and subject to stringent quality controls.

1. Warranty

Bosch offers, at its option, to repair or exchange this Bosch hot water unit or the relevant part listed in clause 2 below at no charge, if it becomes faulty or defective in manufacture or materials during the warranty period also stated in clause 2. This warranty is offered in addition to any other rights or remedies held by a consumer at law.

2. Warranty periods & coverage

- (a) Domestic applications: 3 years (parts and labour)
- (b) Heat exchangers used in domestic applications: 10 years (parts only)
- (c) Commercial applications: 12 months (parts and labour)
- (d) Heat exchangers used in commercial applications: 5 years (part only)

All warranty periods commence on the date of purchase of the hot water unit by the end-user. However, where the date of purchase by the end-user is more than 24 months after the date of manufacture, all warranty periods will automatically commence 24 months after the date of manufacture.

3. Warranty exclusions

This warranty is VOID if any damage to or failure of the hot water unit is caused wholly or partly by:

- (a) faulty installation
- (b) neglect, misuse, accidental or non-accidental damage, failure to follow instructions
- (c) use of the unit for purposes other than which it was designed or approved
- (d) unauthorised repairs or alterations to the unit without Bosch's consent
- (e) use of unauthorised parts and accessories without Bosch's consent
- (f) use of non-potable water or bore water in the hot water unit (see product instructions for further details)
- (g) continued use after a fault becomes known or apparent.

This warranty DOES NOT include:

- (a) costs of consumables or accessories
- (b) wear and tear, normal or scheduled maintenance
- (c) to the extent permitted by law, any damage to property, personal injury, direct or indirect loss, consequential losses or other expenses
- (d) changes in the condition or operational qualities of the hot water unit due to incorrect storage or mounting or due to climatic, environmental or other influences.

NOTE: Any service call costs incurred by the owner or user of the hot water unit for any matter not covered by the terms of this warranty will not be reimbursed by Bosch, even if those costs are incurred during the warranty period. If the hot water unit is located outside the usual operating area of a Bosch service agent, the agent's travel, freight or similar costs are not covered by this warranty and must be paid by the owner or user of the hot water unit.

4. Warranty conditions

- (a) Proof of purchase may be required.
- (b) The hot water unit must be installed by an authorised and licensed installer.
- (c) Proof may be required of the date of installation and correct commissioning of the hot water unit has been carried out to Bosch's satisfaction (such as a certificate of compliance).
- (d) Repair or replacement of the hot water unit or any parts under this warranty does not lengthen or renew the warranty period.



- (e) This warranty is not transferable and is only offered to the original purchaser of the hot water unit.
- (f) No employee or agent of Bosch is authorised to amend the terms of this warranty.
- (g) This warranty only applies to Bosch hot water units purchased from an authorised reseller and installed in Australia or New Zealand.
- (h) To the extent that any condition or warranty implied by law is excludable, such condition or warranty is excluded.

5. How to lodge a warranty claim and warranty procedure

- (a) Warranty claims must be made with the Bosch Customer Contact Centre (Australia: ph 1300 307 037; New Zealand: ph 0800 543 352). Please be ready to provide the model and serial numbers, date of installation, purchase details and a full description of the problem.
Warranty claims must be made before the end of the warranty period.
- (b) All warranty service calls must be conducted by an authorised Bosch service agent.
- (c) Invoices for attendance and repair of a hot water unit by third parties not authorised by Bosch will not be accepted for payment by Bosch.

6. Privacy Act 1988 (Cth)

A customer's personal information collected during warranty claims may be used for the provision of customer support, for the provision of information about products and services and for other marketing activities undertaken by Bosch and its Bosch Service Agents who are authorised to carry out warranty repairs on behalf of Bosch (**Purpose**). Bosch is committed to protecting the privacy of its customers' personal information. It will act in compliance with the National Privacy Principles and *Privacy Act 1988* (Cth). Bosch will not forward customers' personal information to third parties other than for the Purpose. A customer can object at any time to the use of their personal information for the Purpose. Bosch will cease to use a customer's personal information accordingly if an objection is made.

7. Bosch contact details

If you have any questions about this warranty or to lodge a warranty claim, please contact:

Robert Bosch (Australia) Pty Ltd
1555 Centre Road, Clayton, Victoria 3168
Tel: Australia: 1300 307 037
Tel: New Zealand: 0800 543 352

IMPORTANT NOTE FOR AUSTRALIAN CONSUMERS

Our goods come with guarantees that cannot be excluded under the Australian Consumer Law. You are entitled to a replacement or refund for a major failure and for compensation for any other reasonably foreseeable loss or damage. You are also entitled to have the goods repaired or replaced if the goods fail to be of acceptable quality and the failure does not amount to a major failure.